

PACS №: 84.90.+a

Bruce L. Freeman⁺, Larry L. Altgilbers⁺⁺

Alvin D. Luginbill, and James C. Rock

⁺Texas A&M University, TAMUS-3133

College Station, TX 77843-3133 USA

E-mail: bruce.freeman@ne.tamu.edu

⁺⁺ Advanced Technology Directorate,

US Army Space and Missile Defense Command

Development of Small, Tapered Stator Helical Magnetic Flux Compression Generators

Contents

1. Introduction	366
2. Differences between Small and Large Generators	367
3. Previous Work on Tapered Generators	367
4. TAMU Tapered Generators	368
5. 10° Stator Generator	368
6. 12° Stator Generator	369
7. 13° Stator Generator	370
8. Summary	371

Abstract

For some applications of magnetic flux compression generators, shorter pulse widths, with associated higher voltages and power levels, are required. We have developed a family of small, tapered stator generators that begin to address these requirements. Specifically, the three versions of these FCGs developed use stator angles of 10°, 12°, and 13° with respect to the generator axis. These three respective angles resulted in increasingly larger phased closure velocities. The armature diameter is 2.54 cm, and the armature expansion ratio is about 2:1. The shortest dI/dt pulse, in terms of Full-Width-Half-Maximum (FWHM), produced is 398 ns in the current derivative. The peak value for dI/dt is about 3.5×10^{10} amps/sec.

1. Introduction

Some applications for the smaller helical magnetic flux compression generators (FCGs) require shorter pulse widths, higher voltages, higher currents, and higher instantaneous power than can be achieved with conventional cylindrical helical FCGs. Typically, the approach chosen to address these needs with

larger FCGs has been to use a conventional helical FCG coupled through a pulse forming circuit, such as an opening switch or fuse. However, in the case of the smaller generators, there is insufficient energy to drive such circuits. To achieve these parameters more directly, the generator inductance must be reduced more quickly than can be accomplished with the normal propagating detonation and subsequent armature expansion against a cylindrical stator winding. In other words, the FCG change of inductance with time, dL/dt , must be increased. Since the unit of dL/dt is expressed as ohms, this term also

*This work is solely funded by the Explosive-Driven Power Generation MURI program funded by the Director of Defense Research & Engineering (DDR&E) and managed by the Air Force Office of Scientific Research (AFOSR).

represents the generator output impedance. This is another way of considering the FCG requirement to achieve the increases noted earlier. There are several approaches for increasing the change in inductance with respect to time.

One approach that is especially useful in larger FCGs is to use areal or simultaneous initiation of the explosive charge [1]. This may be achieved in either outside-in or inside-out detonations. Generally, the outside-in initiation has been used for high magnetic field experiments [2]. The inside-out simultaneous initiation systems have been successfully used in several generator designs [3]. This geometry has the advantage of dynamically expanding the available conductor for carrying the increasing current. However, the smallest armature size that has used this type of initiator had about a 5-cm diameter. The largest armature size that we have been studying has a diameter of 2.54 cm. Therefore, a different approach is required for increasing the dL/dt of our very small FCGs.

This may be accomplished by tapering the stator diameter to an angle less than the armature expansion angle. This same technique has been used in larger generators as well [4]. Tapering the stator causes the final closure of the armature with the stator to be phased at a much higher velocity than is achievable with the conventionally designed helical FCGs. For example, given a relatively thin aluminum armature with Composition C-4 explosive, the armature expansion angle will be about 15° . Using a stator that is tapered with a 12° angle, the phased closure velocity is ~ 7.3 cm/ms. This velocity is almost a factor of ten larger than the detonation velocity of the C-4 explosive. Therefore, it is practical to effectively accelerate the reduction in the generator inductance.

Disadvantages to this approach include finite length systems and the fabrication and assembly difficulties of the tapered stator. If the design is limited to an armature expansion ratio of 2:1 for reliability, then the expansion of the armature from 2.5 cm to 5 cm provides a progressively shorter stator winding as the angle of the stator is increased. Typically, the fabrication of small stators on a cylindrical form is difficult, but when the taper is added, special care must be exercised to insure that the winding accurately follows the mandrel contour. As indicated in numerous papers, the physical alignment of the stator with the armature axis is important in reducing flux trapping during the generator action [5]. This aspect is made significantly more difficult in the case of the tapered stator.

2. Differences between Small and Large Generators

One way to quantify the differences between small and large generators is to use a figure of merit, which is defined to be the exponent of the ratio of the initial inductance to the final inductance when set equal to the experimental current gain of the generator [6,7]. Large generators, with dimensions on the order of a meter, tend to have figures of merit of approximately 0.85, while smaller generators, with dimensions on the order of 10 cm tend to have a figure of 0.6-0.7 [7]. Even smaller generators, such as those with a 30 mm outer diameter have a figure of merit of about 0.6 or less. This implies that there are differences in the performance of small generators (sometimes referred to as *mini-generators* or simply *minigens*) versus larger generators. Smaller generators exhibit higher flux losses and lower current gains. It appears that higher current loading in the small generators [6] and tapering the generator [7] could lead to improved performance.

3. Previous Work on Tapered Generators

Tapered armatures and stators have been used in larger generators for many years, but the first reporting on small tapered generators was that by Lawrence Livermore National Laboratory [8]. They built a 4 stage helical FCG with a armature of length 8.04 cm that tapered outward at a 4° angle 4.13 cm from the input end of the generator.

A second paper that specifically addressed the impact of tapering on flux losses in FCGs was published by Texas Tech University (TTU) [7]. Texas Tech looked at three different generators, whose parameters are summarized in Table I: TTU II with a straight armature and straight stator, TTU VI with a straight armature and tapered stator, and TTU X with a tapered armature and a partially straight and partially tapered stator. The basic conclusions of the TTU study are:

- 1) the figure of merit of small sized and straight armature-stator generators is limited to about 0.6,
- 2) generators with a tapered stator and straight armature performed slightly better than generators with straight stators and armatures, and
- 3) generators with straight stators and tapered armatures exhibit a distinctly inferior performance.



Fig. 1. Mark 100 generator.

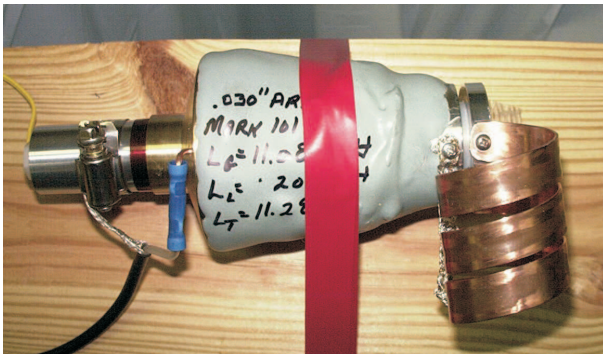

Fig. 2. Mark 101 generator.



Fig. 3. Mark 103 generator.

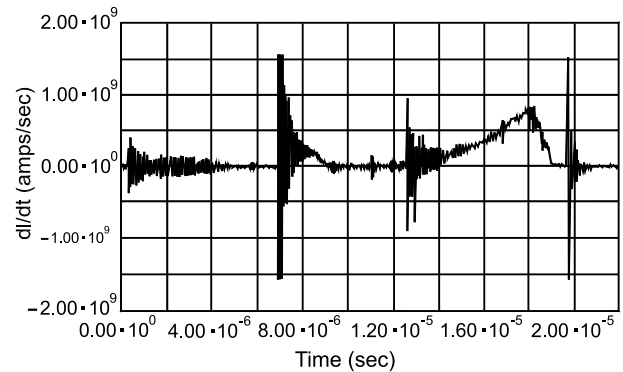

Fig. 4. The current derivative signal is shown for the first test of the Mark 100 generator.

4. TAMU Tapered Generators

As noted earlier, three variants of tapered generators were built and tested at Texas A&M University (TAMU). Their parameters are summarized in Table II. All three generators had straight armatures, but stators tapered at different angles. They were designated Mark 100 (Figure 1) with a taper angle of 10° , Mark 101 (Figure 2) with a taper angle of 12° , and Mark 103 (Figure 3) with a taper angle of 13° . The experimental results for each generator are provided. It will be noted that the fabrication difficulty increase with each increase in the stator taper angle.

5. 10° Stator Generator

The 10° tapered stator design was our first generator fabricated and tested for this style generator. The reason for selecting the rather conservative angle was that we were aware of the work at Texas Tech and the University of Missouri at Rolla with similar geometries [9]. Their work indicated that the expansion of angle of the 2.54-cm diameter aluminum armatures could be significantly under driven with the Composition C-4 explosive. Thus, it was prudent to begin with a stator angle that

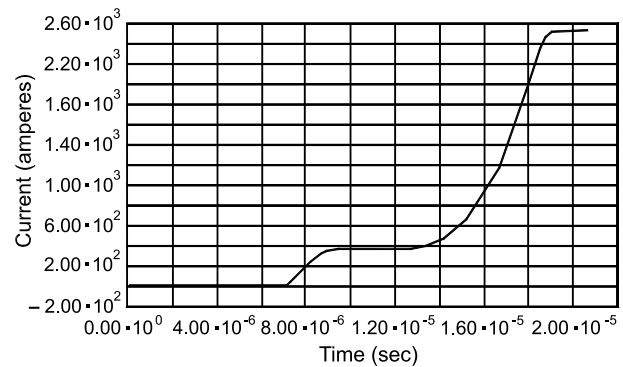

Fig. 5. The current for the first test of the Mark 100 is shown.

would be significantly less than any expected armature expansion angle.

Starting with a general 10° requirement on the stator taper, the TAMU Mark 100 generator was designed on a base of a 2.54-cm o.d., 1-mm wall armature tube. The design expansion was a factor of two and the resulting stator length was 6.985 cm. The first two of these generators were built using 14 gage, round magnet wire with a layer of heat shrinkable tubing added for additional turn-to-turn and stator-to-armature insulation. With 29 turns of a single wire, the initial FCG inductance in test #1 was $\sim 9.436 \mu\text{H}$.

The passive load inductance for the first two systems was about 466 nH. The explosive charge for these FCGs was ~ 90 grams.

Figures 4 and 5 provide the time histories of the current derivative or dI/dt and the current for the first Mark 100 experiment. The initial current was 343 A and the final current was 2.55 kA, for a current gain of 7.40:1. The energy gain was 2.51:1. The magnetic flux efficiency was 34.5%. The alpha for this FCG was 0.655. The FWHM (Full-Width-Half-Maximum) time for the peak in the dI/dt trace was $2.2 \mu\text{s}$, or about half of the pulse width that we had observed from similar-sized, straight stator helical FCGs. The load voltage for this test was ~ 460 V and the instantaneous power in the load was ~ 0.73 MW. These results were well above the previous measurements on the generators that we had tested at that time.

Over four tests, we found that the gains were reasonably consistent. There was no indication that the stator angle was close enough to the armature expansion angle to cause difficulties. While the 10^0 tapered FCG did provide reliable performance, it did not provide the desired degree of pulse sharpening. Nevertheless, the initial design proved to be constructive from the viewpoints of gaining experience in testing these types of generators and resolving fabrication issues.

6. 12^0 Stator Generator

Given the experience with the 10^0 taper in the Mark 100, the next step was to attempt to achieve a significant reduction in the FWHM for the generator. A 12^0 stator taper was selected as the next increment in the development. While the armature diameter was held constant from the Mark 100, the expansion ratio was extended to 2.17:1, where the inner radius of the stator was 5.51 cm. This extension permitted the length of the stator winding to be slightly longer. The additional removal of the shrink tubing left space for four more turns on the stator for 12 gage magnet wire, for a total winding of 33 turns. The initial generator inductance for experiment #9 was $11.031 \mu\text{H}$ and the static load inductor for this shot was 189 nH.

From Figures 6 and 7, test #9, with an initial current of ~ 1 kA, produced a final current of 11.6 kA with a dI/dt FWHM peak of $\sim 1.26 \mu\text{s}$. Given the load inductance, the maximum load voltage was ~ 2.4 kV and the peak instantaneous power was ~ 29 MW. The figure of merit, α , was 0.60, the magnetic flux efficiency was 22.9 %, and the energy gain was 2.28:1. The dI/dt trace in Fig. 6 does indicate that significant turn skipping is occurring, which is most easily explained by a slight axial displacement between the stator and the armature axes. The voltage and power output for the Mark 101 FCGs represented significant improvements over all of the previous generators that

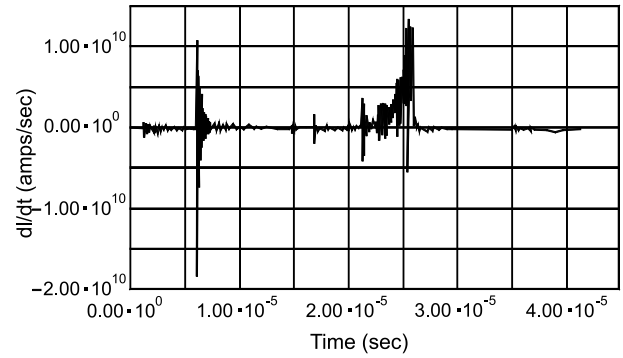

Fig. 6. The time history of the dI/dt for the 9th test of the Mark 101 is plotted.

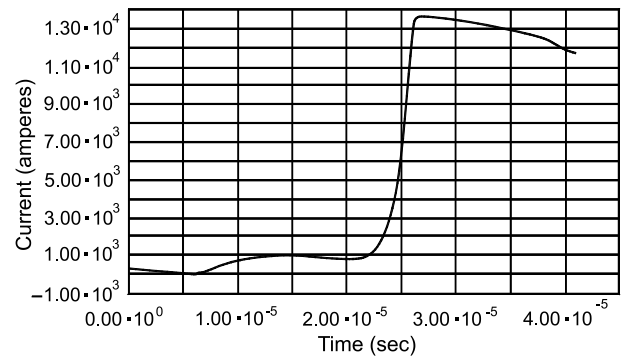

Fig. 7. The current as a function of time is plotted for the Mark 101 Test #9.

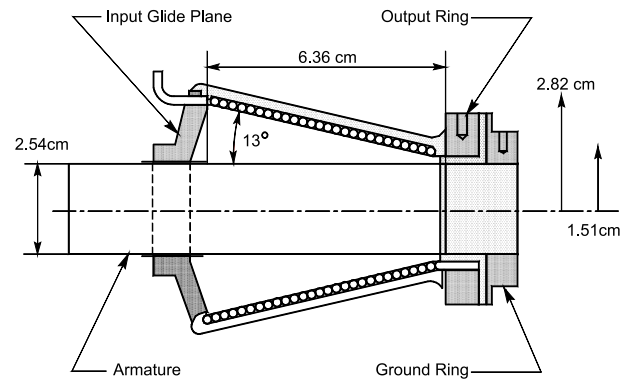

Fig. 8. A sketch of the Mark 103 generator is shown.

we had tested at TAMU. In fact, the figures of merit appeared to be generally as good as any other small generator designs tested.

While these performance figures are not as good as would be expected in larger systems, they represent reasonable output for a small generator. In fact, the surprise is that degradation in the figures of merit is normally expected when generator pulse shaping is attempted. This has not been seen in the Mark 101 tests. In fact, the 12^0 -tapered stator FCG performed so consistently that it is clear that the stator taper and the armature expansion angles are still significantly different. As a result of this

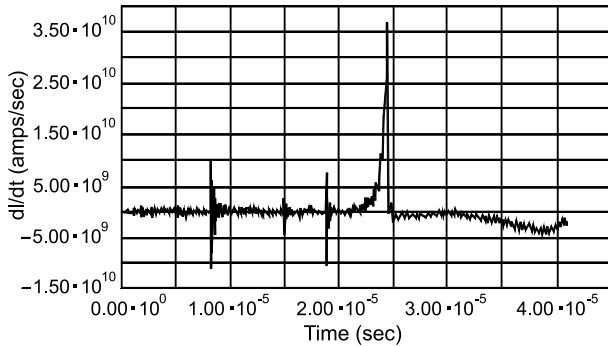

Fig. 9. The time history of the current time derivative is plotted for the Mark 103 Test #2. The very clean rise of the pulse is a good indication of a very good axial alignment between the stator and the armature.

reasonably consistent behavior, this design provided the required improvement in pulse width and power level to enable some applications.

7. 13^0 Stator Generator

With time, we have further improved our fabrication techniques to the point that a larger stator taper angle was a reasonable extension for this development effort. Also, some of the applications could benefit from a faster output pulse from the generator than is possible from the Mark 101 offers. Thus, the Mark 103 generator uses a 13^0 -stator taper (See Fig. 8). In this model, we expanded the armature slightly to have an inner diameter of 2.54 cm. The armature wall thickness was also reduced to 0.76 mm. For the second test of the Mark 103 generator design, the initial FCG inductance with #14 gage magnet wire was $16.069 \mu\text{H}$ and its passive load inductance was 30 nH.

With the very high ideal gain for this experiment, we did not expect the a to be very large. Nevertheless, a distinguishing characteristic of this test is that the current derivative, dI/dt , trace indicated the cleanest generator performance that we have observed in these small systems, Figures 9 and 10. The initial current was 912 A and the final current was 20.73 kA. Thus, the current gain was 22.7:1, but the a was only 0.497. The associated energy gain was also less than unity, as one would expect, at 0.96:1. The more important point is that the FWHM of the dI/dt pulse was reduced to 398 ns. The peak voltage (Fig. 11) was about 1.09 kV and the maximum instantaneous power (Fig. 12) delivered to the load was 28.7 MW with a FWHM value of ~ 250 ns. Using these current and voltage results, the effective generator impedance was ~ 53 m Ω . Given the process that is used for this part of the analysis, the lack of flux pocketing indication on this trace is very surprising.

The performance of the first experiment of this

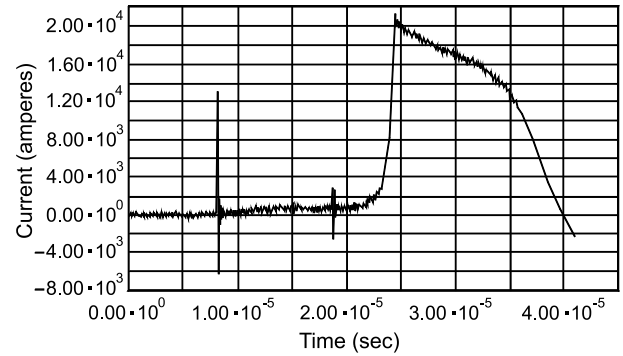

Fig. 10. The current as a function of time is plotted for the Mark 103 Test #2. The maximum current of ~ 21 kA is a very good result for a small, pulse-shaped generator.

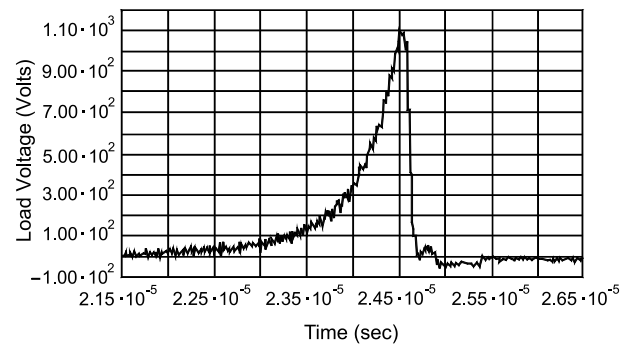

Fig. 11. With an expanded time scale, the voltage across the load inductance of the Mark 103 Test #2 remains clean and rises to 1,089 volts.

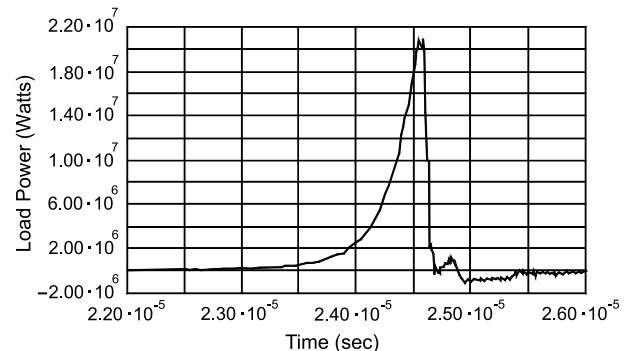

Fig. 12. Using the same expanded time scale as for Fig. 8, this plot illustrates the time history of the power delivered to the load inductor for the Mark 103 Test #2.

generator was problematic. Nevertheless, data was acquired that shows that it also performed well. Its initial inductance was $16.536 \mu\text{H}$ and the passive load inductance was 161 nH. The initial current for the test was 992 A. The final current was 16.34 kA. The figures of merit for this experiment are an a of 0.604, a magnetic flux efficiency of 15.9 %, and an energy gain of 2.62:1. The FWHM of the current derivative pulse

was ~ 520 ns, a bit longer than the second test. The peak voltage and power into the inductive load were 2.60 kV and 37.4 MW, respectively.

8. Summary

The goal of this research was to shorten the pulse width of the dI/dt , increase the voltage, increase the output impedance, and increase the instantaneous power of a very small form factor magnetic flux compression generator. A 2.54-cm diameter armature is the scale dimension used in this instance. While there are several approaches for achieving this pulse shortening in larger generators, usually by using area initiation techniques, we were severely limited by the size of our armatures. Thus, the only viable approaches for the very small FCGs appears to be the use of a tapered stator or tapered stator to achieve high values of dL/dt through large effective phased closure velocities. The tapered stator was selected for its relative ease of fabrication and elimination of the enhanced need for modeling that the tapered armature would have imposed on the design. We have designed three versions of this generator and each succeeding version produced a shorter pulse than the previous design. The taper angles of the three stator designs have been 10° , 12° , and 13° . The Full-Width-Half-Maximum (FWHM) values of the times for each of these designs have decreased with increasing stator angle. The three representative times are 2.20 μs , 1.26 μs , and 0.398 μs , respectively.

Manuscript received August 1, 2003

References

- [1] R.S. Caird and C.M. Fowler, "Conceptual Design for a Short-Pulse Explosive-Driven Generator," in Proc. 4th Megagauss Magnetic Field Generation and Pulsed Power Applications, 1986, P.425.
- [2] A.I. Pavlovskii, M.I. Dolotenko, N.P. Kolokol'chikov, A.I. Bykov, O.M. Tatsenko, and B.A. Bojko, "Cascade Magnetocumulative Generator of 20 MG Range Magnetic Fields," in Proc. 6th Megagauss Magnetic Field Generation and Pulsed Power Applications, 1993, P.141.
- [3] B.L. Freeman, M.G. Sheppard, and C.M. Fowler, "A Numerically Designed, Experimentally Tested, High-Current, Coaxial Generator," in Proc. 6th Megagauss Magnetic Field Generation and Pulsed Power Applications, 1993, P.565.
- [4] F.S. Felber, R.S. Caird, C.M. Fowler, D.J. Erickson, B.L. Freeman, and J.H. Goforth, "Design of 20 MJ Coaxial Generator," in Proc. 3rd Megagauss Magnetic Field Generation and Pulsed Power Applications, 1983, P.321.
- [5] V.K. Chernyshev, E.I. Zharinov, S.A. Kazakov, V.N. Busin, V.E. Vaneev, and M.I. Korotkov, "Magnetic Flux Cutoffs in Helical Explosive Magnetic Generators," in Proc. 4th Megagauss Magnetic Field Generation and Pulsed Power Applications, 1986, P.455.
- [6] B.L. Freeman, L.L. Altgilbers, C.M. Fowler, J.C. Boydston, J.M. Ferguson, B.A. Lindeburg, A.D. Luginbill, and T.E. Tutt, "Similarities and Differences Between Small FCG's and Larger FCG's", Journal of Electromagnetic Phenomenon, in preparation.
- [7] A.A. Neuber, T.A. Holt, J. Hernandez, J.C. Dickens, and M. Kristiansen, "Geometry Impact on Flux Losses in MCGs", in Proceedings of the 9th Megagauss Conference, to be published.
- [8] D.K. Abe and J.B. Chase, "Experiments with Small Helical Flux Compression Generators", Megagauss Magnetic Field Generation and Power Applications, pp. 405 - 409 (1994).
- [9] A. Neuber, J. Dickens, H. Krompholz, M. Kristiansen, "Optical Diagnostics on Helical Flux Compression Generators," in Proc. 12th IEEE International Pulsed Power Conference - 1999, p. 632.

Table 1. Characteristics of the Texas Tech generators

Generator	Geometry	Armature OD (mm)	Stator ID (mm)	Stator Length (mm)	Number of Turns	Stator Wire	Input Field/ Current	Peak Current (A)	α	Current Gain	Energy Gain
TTU II	SINGLE HELIX WIRE	38.1	89	102	32	Electric Wire	875	78000	0.6949	89.14	12.41
TTU VI	TAPERED HELIX	38.1	66	130	32	AWG12 Electric Wire	501	79897	0.7198	159.55	22.14
TTU X	TAPERED ARMATURE	39-59	82	80	23	PVC Insulated AWG 12	96	3389	0.7667	35.44	11.967

Table 2. Characteristics of the Texas A&M generators.

Generator	Geometry	Armature OD (mm)	Stator ID (mm)	Stator Length (mm)	Number of Turns	Stator Wire	Input Field/ Current	α	Current Gain	Energy Gain
Mark 100	10 Tapered, 1 Det.	2.54	5.02-2.56	6.985	29	# 14 Magnet	9.436/9.817 A	0.655/0.648	7.40/7.52	2.58/2.51
Mark 100a	10 Tapered, 1 Det.	2.54	5.02-2.65	6.985	27	# 12 Magnet	7.224/7.060 A	0.629/0.631	8.04/8.37	2.35/2.42
Mark 101	12 Tapered, 1 Det.	2.54	5.53-2.65	6.985	31	# 12 Round	10.147-11.310 A	0.475-0.666	6.52-10.97	0.82-3.15
Mark 101a	12 Tapered, 1 Det.	2.69	5.53-2.65	6.985	33	# 12 Round	1008 A	0.693	13.59	3.11
Mark 101b	12 Tapered, 1 Det.	2.69	5.644-3.005	6.985	41	# 14 Round	1032/3000 A	0.604/5.31	16.34/11.68	2.62/1.33
Mark 103	13 Tapered, 1 Det.	2.54	5.64-3.00	6.53	38	# 14 Round	992/912 A	0.604/0.497	16.47/22.73	2.62/0.96